

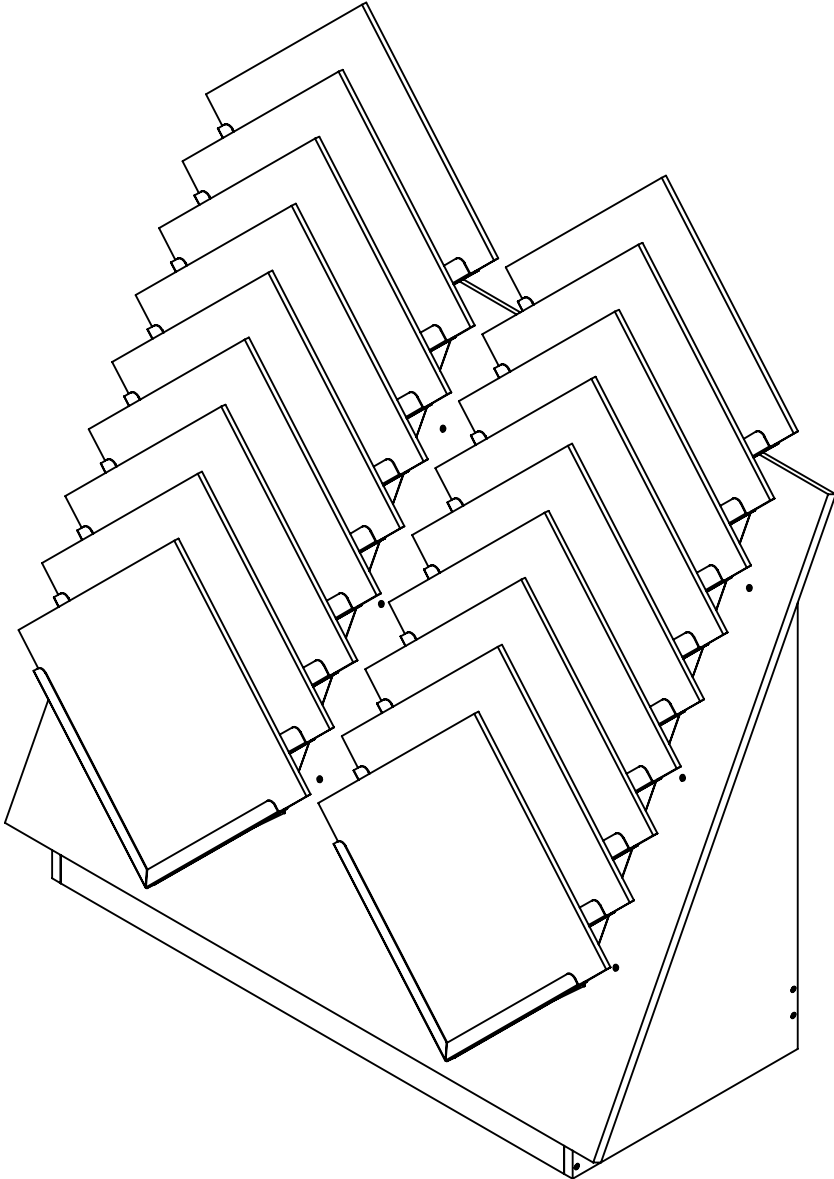

Elevations
LOOSE TILE DISPLAY
(EL-LOOSE TILE-09)
ASSEMBLY INSTRUCTIONS
63"H x 52"W x 21.5"D

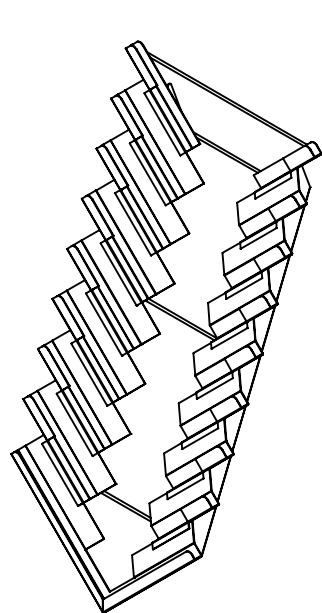

PARTS



TILE TRAY
(2)

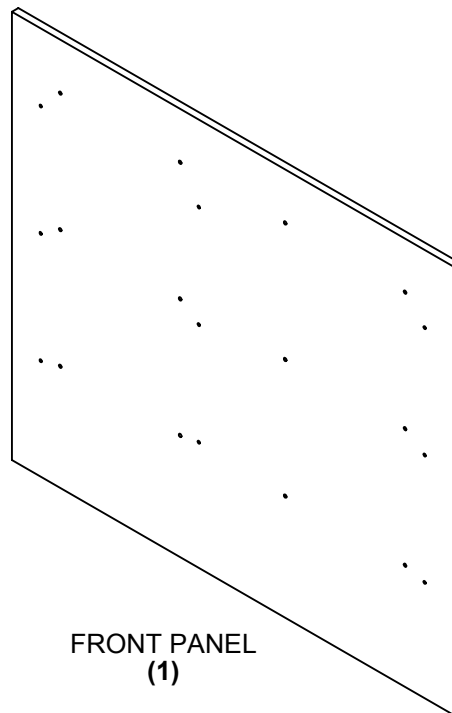

FRONT PANEL
(1)

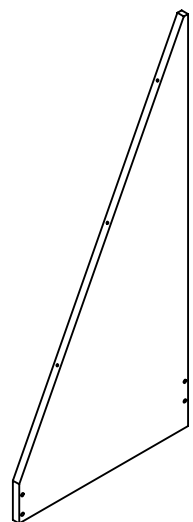

SIDE PANEL
(2)

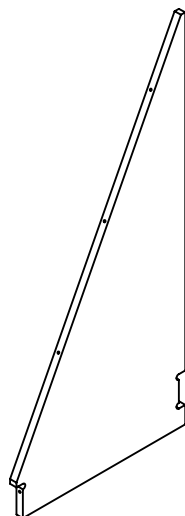

CENTER PANEL
(1)

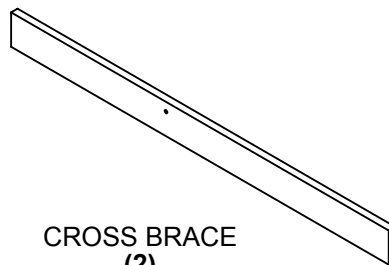

CROSS BRACE
(2)

HARDWARE

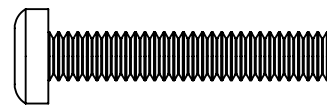

1-1/2" BOLT
(12)

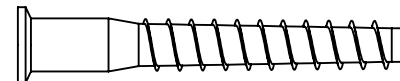

CONFRAMAT
(19)

TOOLS & SAFETY

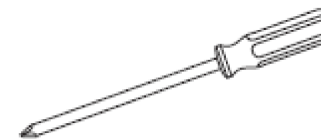

Phillips Screwdriver

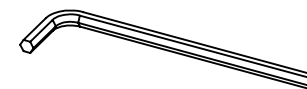

4mm Hex

Two or more people are recommended for unpacking, assembly, and moving. Failure to do so may result in failing of the unit.

Failure to follow the assembly directions could result in damage or injury.

Install in a level and stable location.

Assemble display in the area it will occupy. Never attempt to move display after loading.



STEP 1

Attach (2) **CROSS BRACES** to the **CENTER PANEL** using (2) **CONFRAMATS**.

Attach (2) **SIDE PANELS** to the **CROSS BRACES** using (4) **CONFRAMATS** for each **SIDE PANEL**.

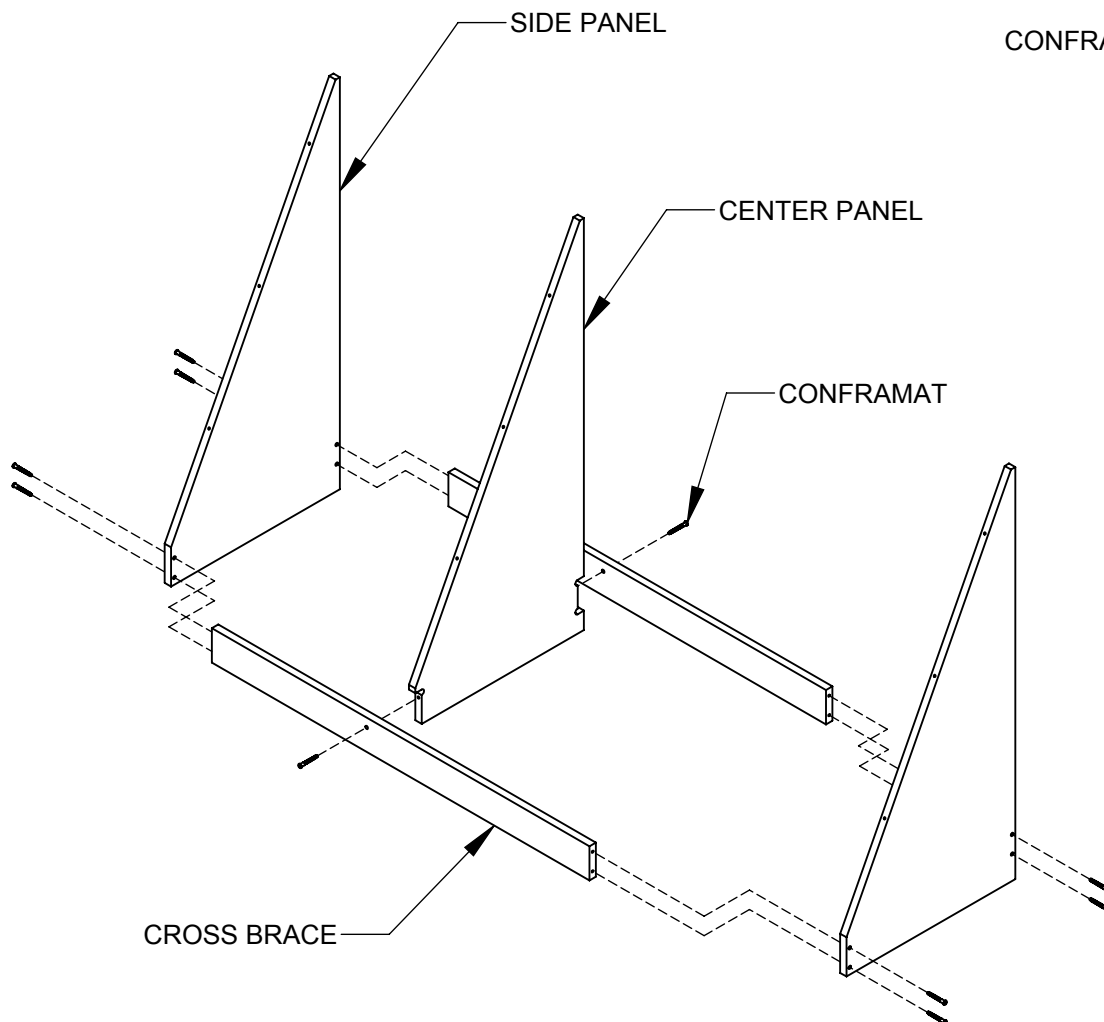

STEP 2

Attach (1) **FRONT PANEL** to the (2) **SIDE PANELS** and **CENTER PANEL** using (9) **CONFRAMATS**.

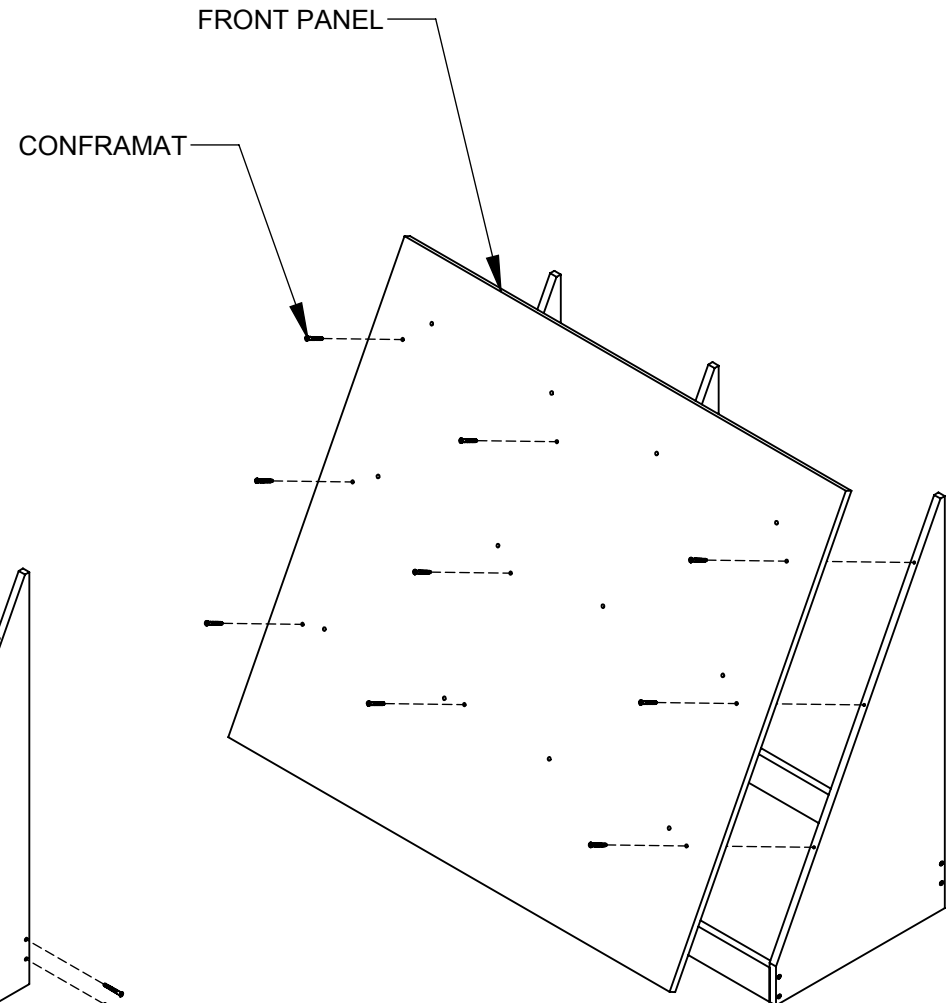

STEP 3

Attach (2) **TILE TRAYS** to the **FRONT PANEL** using (6) **1-1/2" BOLTS** from behind the **FRONT PANEL** into each **TILE TRAY**.

